

## MODELOS DE MARTILLO

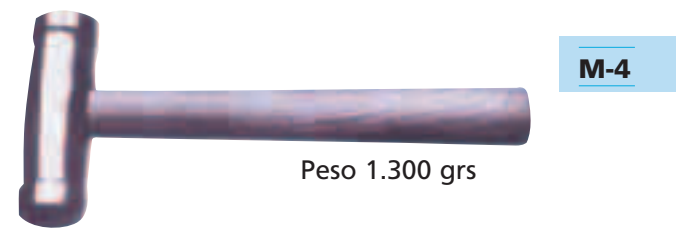

## MODELOS DE TAS

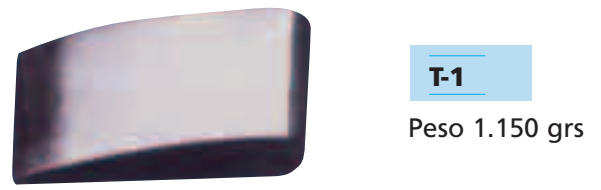

## MODELOS DE TASES

|              |           |           |
|--------------|-----------|-----------|
| <b>82549</b> | Dactilado | 80x56x26  |
| <b>82550</b> | Dactilado | 80x56x31  |
| <b>82551</b> | Dactilado | 92x58x28  |
| <b>82552</b> | Comma     | 116x66x19 |



**82549    82550    82551    82552    82553**

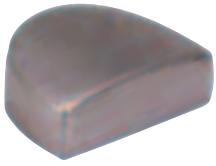

**TAS DE TACON**

**22917** 83x63x36 mm



**TAS DE COMA**

**22553** 140x54x55 mm



**TAS DACTILADO PLANO**

**22918** 88x60x23 mm

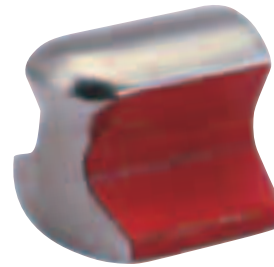

**TAS RAIL**

**22904** 76x57x58 mm



**TAS DACTILADO PLANO**

**22919** 115x56x25 mm



**TAS DOPPEL**

**22916** 76x80x62 mm



**TAS DACTILADO PLANO**

**22928** 125x60x30 mm



**TAS YUNQUE**

**22920** 102x72x62 mm



**TAS DACTILADO ESTRIADO**

**22915** 125x60x30 mm



**TAS CARRETE**

Modelo Diabolo

**22554** 56x56x56 mm



### TAS DACTILADO EXTRAPLANO

Angular, suela

**22921** 106x59x18 mm



### TAS CUÑA CURVA

**22922** 130x68x25 mm



### TAS CUÑA RECTA

**22923** 110x62x28 mm

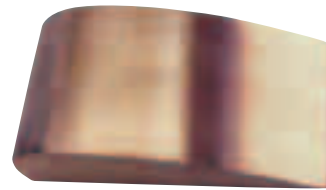

### TAS CUÑA CURVA

**22924** 115x55x30 mm



### TAS SUELA CON CANAL

**22925** 106x65x26 mm



### TAS DACTILADO PLANO

Caras con terminación angular

**22926** 115x55x30 mm



### SALVAGRAPAS ESPECIAL PORTÓN TRASERO

Techos del grupo Vag

**81014** 106x65x26 mm



### MORDAZA DE TIRO

**41490**

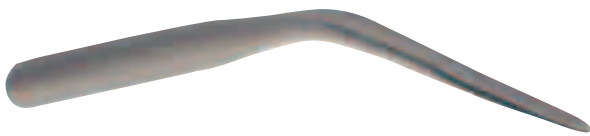

## PALANCA DE CUCHARA PLEGADA

| 22901 | L<br>mm | Kg  |
|-------|---------|-----|
|       | 250     | 0,5 |



## PALANCA CORTA DE CUCHARA

| 22903 | L<br>mm | Kg  |
|-------|---------|-----|
|       | 285     | 0,8 |



## PALANCA LARGA DE CUCHARA

| 22902 | L<br>mm | Kg  |
|-------|---------|-----|
|       | 390     | 1,3 |

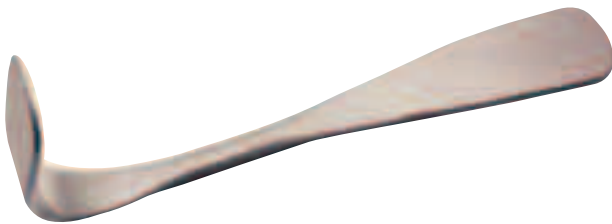

## PALANCA CURVA Y PLANA

| 22911 | L<br>mm | Kg  |
|-------|---------|-----|
|       | 400     | 1,7 |



## PALANCA PLEGADA Y PLANA

| 22912 | L<br>mm | Kg  |
|-------|---------|-----|
|       | 510     | 2,2 |



## PALANCA CON LENGÜETA DE CUERO

| 22914 | L<br>mm | Kg  |
|-------|---------|-----|
|       | 400     | 1,2 |



## LIMA PARA TERMINACIONES

| 81360 | L<br>mm | Kg  |
|-------|---------|-----|
|       | 350     | 0,7 |

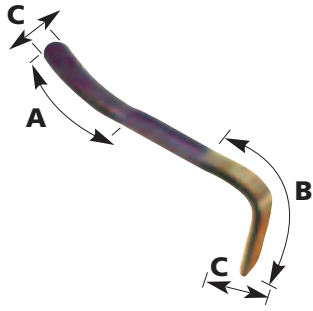

## PALANCA CARROCERO

|       | A   | B   | C  | PESO |
|-------|-----|-----|----|------|
| 88122 | mm  | mm  | mm | grs  |
|       | 120 | 200 | 40 | 1200 |

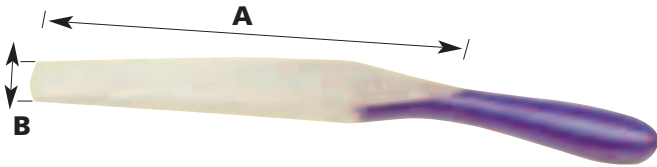

## PALANCA CARROCERO

|       | A   | B  | PESO |
|-------|-----|----|------|
| 88123 | mm  | mm | grs  |
|       | 170 | 25 | 600  |

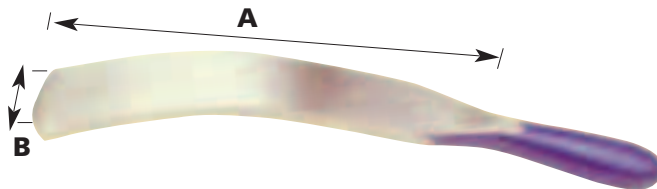

## PALANCA CARROCERO

|       | A   | B  | PESO |
|-------|-----|----|------|
| 88124 | mm  | mm | grs  |
|       | 230 | 45 | 900  |

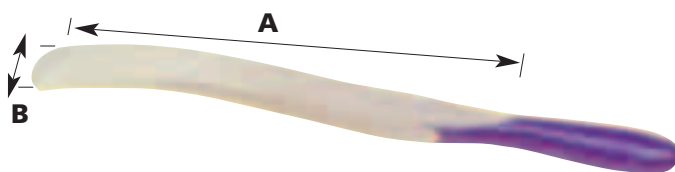

## PALANCA CARROCERO

|       | A   | B  | PESO |
|-------|-----|----|------|
| 88125 | mm  | mm | grs  |
|       | 230 | 45 | 900  |

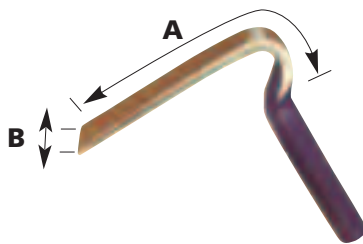

## PALANCA CARROCERO

|       | A   | B  | PESO |
|-------|-----|----|------|
| 88126 | mm  | mm | grs  |
|       | 240 | 50 | 1000 |

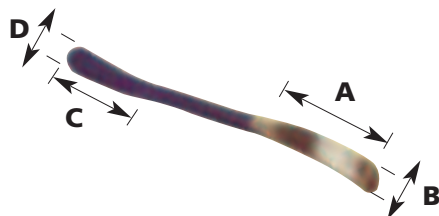

## PALANCA DOBLE CURVA RECTO

|       | A   | B  | C   | D  | PESO |
|-------|-----|----|-----|----|------|
| 88127 | mm  | mm | mm  | mm | grs  |
|       | 220 | 50 | 140 | 45 | 1000 |

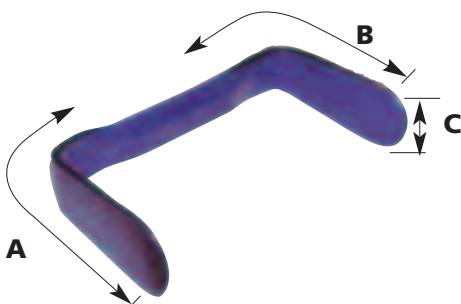

## PALANCA HORQUILLA 2 CARAS

|       | A   | B   | C  | PESO |
|-------|-----|-----|----|------|
| 88128 | mm  | mm  | mm | grs  |
|       | 170 | 160 | 45 | 1100 |

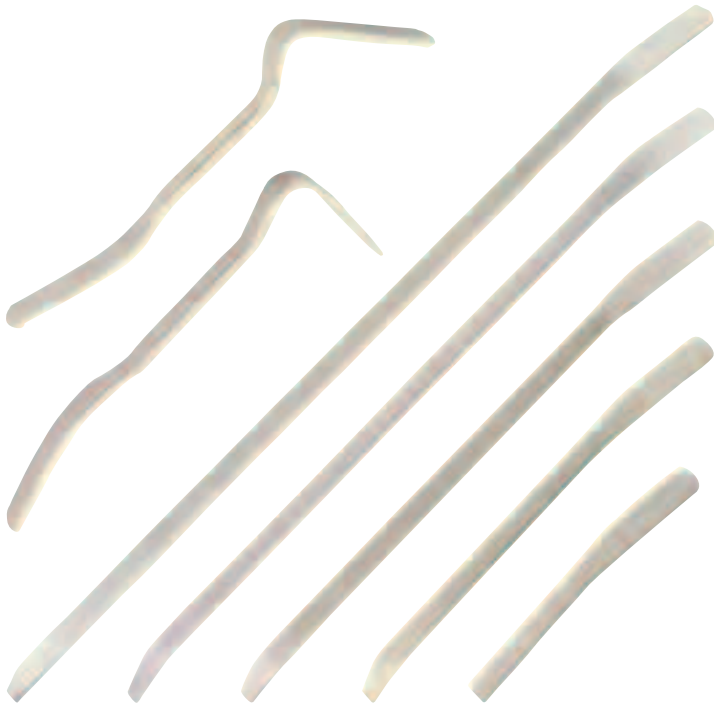

## PALANCAS DE CARROCERO

| Item  | Length |
|-------|--------|
| 82535 | 380 mm |
| 82536 | 380 mm |
| 82537 | 900 mm |
| 82538 | 750 mm |
| 82539 | 600 mm |
| 82540 | 450 mm |
| 82541 | 240 mm |



## ESTUCHE PALANCAS PARA CARROCERÍA

9 unidades

88548



## DESTOR GOLPE ESPECIAL PARA AUTOMÓVIL

63205



## TAS HACHA JAPONÉS

82542 125 mm ancho x 255 mm largo

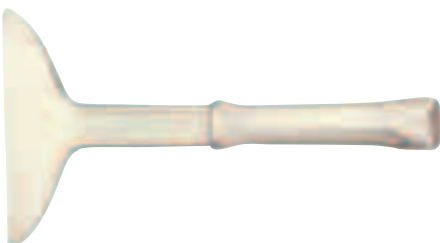

## TAS HACHA JAPONÉS

82543 137 mm ancho x 255 mm largo



**MARTILLO PEÑA**  
Con base de goma

62530



**MARTILLO PEÑA**  
Ligero

62531

Diseño original



**MARTILLO PEÑA**  
110 grs.

62592



**MARTILLO PEÑA**

62535

Diseño original



**MARTILLO BOLA**  
110 grs.

64593



**MARTILLO PEÑA**  
Vertical

62532

Diseño original



**DESTORGOLPE**

63207



**DESTORGOLPE**

92650



**MAZA DE PEÑA**  
Vertical - Ø 36 mm

62534



**MAZA DE PEÑA**

62533



**55870**

### MARTILLO DE BRONCE

420 grs



**55871**

### MARTILLO DE BRONCE

810 grs



**55872**

### MARTILLO DE BRONCE

1050 grs



### JUEGO MARTILLOS Y BOTADURAS DE BRONCE

Antichispa, para mecánica y carrocería de aluminio

**63806**

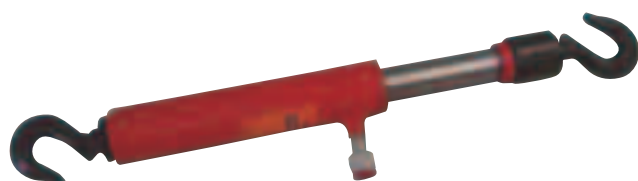

### CILINDRO DE ENCOGER 5 TONELADAS

**63807**



### PORTALIMAS REGULABLE

Reglaje con tornillo para adaptar la lima a superficies planas o curvas

**32176**



### LIMA PLANA FLEXIBLE

Para utilizarla acoplada al portalimas

**32177**



### ÚTIL PARA ALINEAR PUERTAS

**83538**



### RASQUETA DE 3 FILOS

**82032**



## MORDAZA DE TIRO

2 posiciones

**86601**

Capacidad de tiro 10 Ton

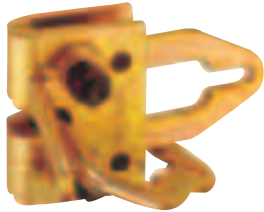

## MORDAZA DE TIRO

Multiposiciones de tiro

**88602**

Capacidad de tiro 5 Ton

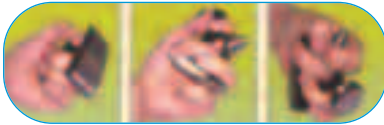
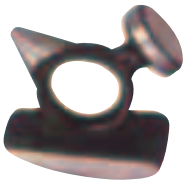

## MINI TAS MULTIUSO

Tas miniatura con diferentes perfiles para zonas de difícil acceso

**81685**



## METRO TELESCÓPICO

Para medidas de carrocería  
40000

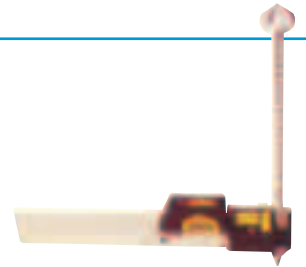

## LIMA DE REPASAR

**81360**



## REMACHADORA

Hasta 5 mm Ø aluminio en acero y 260 mm de longitud

**27329**



## MARTILLO DE PEÑA

Curbo

**61931**



## ESCARPA PLANCHISTA

92008

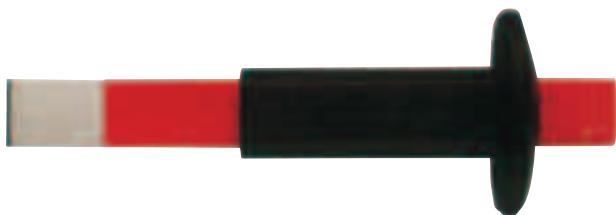

## ESCARPA PLANCHISTA

Con protección

92009



## ESCARPA PLANCHISTA ANCHA

Con protección

92010



## ESCARPA PLANCHISTA PARA DESENSAMBLAR PLANCHA

92007

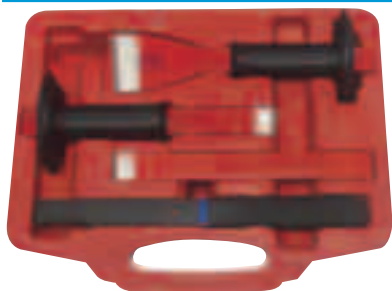

Diseño original



## JUEGO 4 ESCARPAS PLANCHISTA

82509



## ESCARPA PARA PUNTOS DE SOLDADURA

En lugares estrechos, vierteaguas, etc...

88359

250x10x8

88360

250x10x10



## TIJERA PARA MOLDURAS DE GOMA

33663

43020



## RASCADOR DE JUNTAS CON WIHA MANGO DE FUERZA

Rascador de juntas con Wiha mango de fuerza  
Varilla de acero cromo-vanadio, templado continuo, cromado en mate, Wiha mango de fuerza de acetil celulosa, resistente a golpes, rojo, exento de cadmio  
Uso: para quitar de forma limpia juntas y restos de juntas en la industria del automóvil, o.ej. cilindros, tapas de válvulas, carburadores, etc...



**11121**

## JUEGO SACAPASADORES DE PUERTA



**11122**

## JUEGO SACAPASADORES DE PUERTA



## BARRA SACAPASADORES

**11113** R-21 y univ.

**11114** Ford - Opel - Nissan

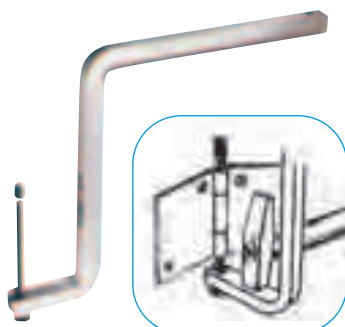

## ESCUADRA SACAPASADORES

**11112**

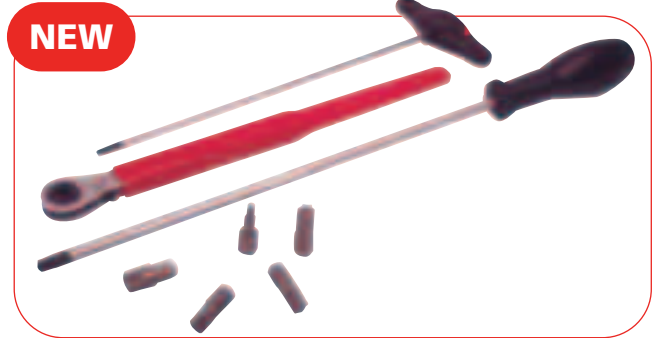

**NEW**

## JUEGO PARA EXTRAER BISAGRAS DE PUERTA

**83726**

Aplicación modelos: Audi, Mercedes, Porsche, VW, Renault, etc...

Fácil extracción de las bisagras gracias a este kit específico compuesto por una carraca extra larga para accesos difíciles y dos destornilladors largos además de cinco puntas específicas para los modelos indicados

Destornilladores TORX: Corto T5, Largo T8

Puntas XZN 5/16": M4, M8, M10

Puntas TORX 5/16: T8, T11

Llave de Carraca 5/16"



## CONJUNTO SACAPASADORES DE PUERTA

Útil universal tornillos visagra de puerta en caja de PVC con 5 special-bits de 5/16"

**12150**

T-40 golf-III

T-45 Golf + Vento + Seat cord + Ibiza

XZN-8 Golf-IV + Passat>97 + Seat Arosa

XZN-10 golf-IV + Polo + Passat + Audi>97

T-30 Renault u.a.



## VARILLAS SACAPASADORES

**11115** 3,85 x 80 mm

**11116** 3,85 x 110 mm

**11117** 5 x 110 mm

**11118** 5 x 125 mm

**11119** 5,50 x 110 mm

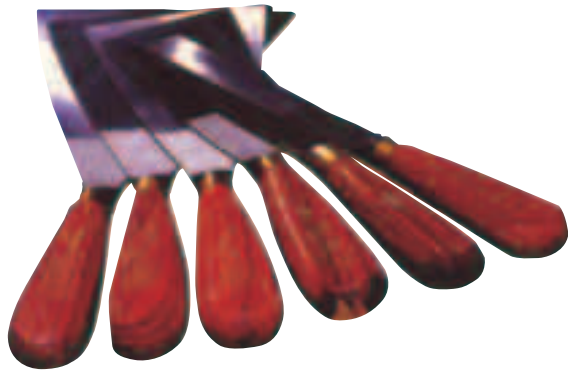

## ESPÁTULAS INGLESAS PARA MASILLAS

|       |        |
|-------|--------|
| 23011 | 2 cms  |
| 23012 | 4 cms  |
| 23013 | 6 cms  |
| 23014 | 8 cms  |
| 23015 | 10 cms |
| 23016 | 12 cms |

## JUEGO ESPÁTULAS INGLESAS

23017

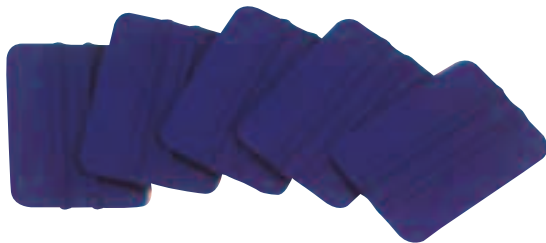

## JUEGO ESPÁTULAS DE GOMA

61212



## ALICATE PARA GRAPAS DE TAPIZADO

En estuche y grapas

12108

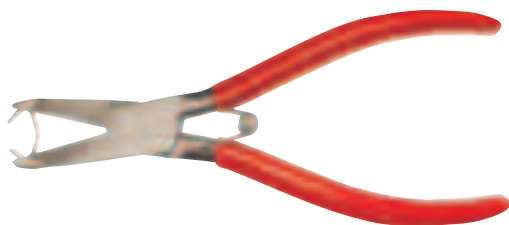

## ALICATE PARA GRAPAS DE TAPIZADO

Para fijar garras de tapicería en asientos de vehículos de distintos fabricantes

12110



## BOLSA DE 500 GRAPAS

12109

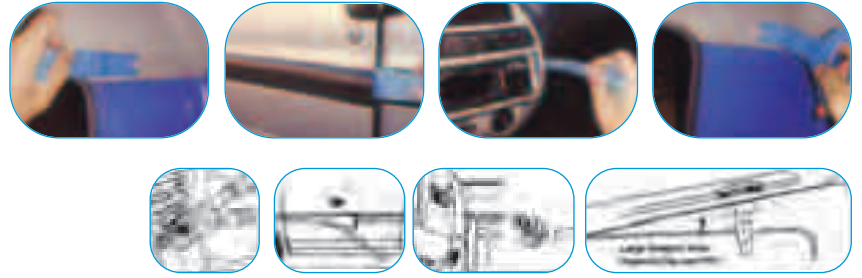

**22109**

## KIT CUÑAS DE PVC PARA TAPICERÍA Y CARROCERÍA

5 unidades



## KIT CUÑAS DE PVC PARA TAPICERÍA DE CARROCERÍAS

Salvagrapas y desmontaje de molduras y paños, etc  
11 piezas

**81902**

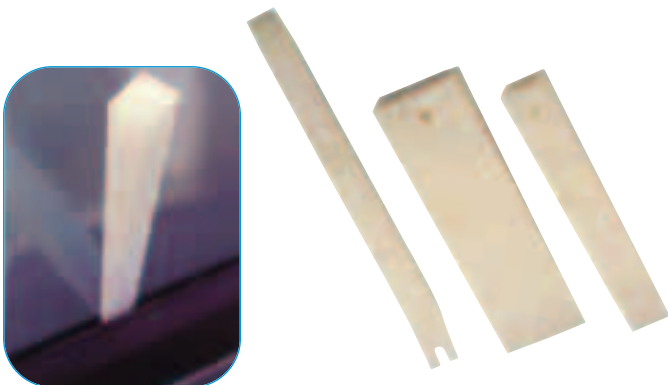

## JUEGO CUÑAS DE NYLON

Para multiples servicios en la carrocería del automóvil

**10724**



## ESPÁTULA EXTRA FINA DE ACERO INOXIDABLE

Para despegar molduras y revestimientos de salpicaderos y carrocería del automóvil

**81128**

## HERRAMIENTAS PARA REPARACIÓN AUTOMÓVIL

### MAZAS DE MADERA PARA CARROCERÍA DE ALUMINIO



68678



68679



68675



68676



68677

### MAZAS DE MADERA

|              | mm    | mm  | g  |
|--------------|-------|-----|----|
| <b>12173</b> | 70x32 | 190 | 60 |



|              | mm    | mm  | g  |
|--------------|-------|-----|----|
| <b>12174</b> | 95x34 | 215 | 80 |



|              | mm    | mm  | g   |
|--------------|-------|-----|-----|
| <b>12175</b> | 80x54 | 200 | 100 |

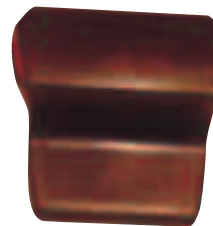

**TASES CON RECUBRIMIENTO DE GOMA PARA CARROCERÍAS DE ALUMINO****TAS CUÑA****80812****NYLON****TAS TACÓN****70821****GOMA - METAL****TAS MEDIA LUNA****80813****NYLON****TAS DACTILADO****70820****GOMA - METAL****TAS HACHA****80814****NYLON****TAS CARRIL****70825****GOMA - METAL****TAS COMA****70827****GOMA - METAL****MARTILLO DE GOLPEO****70826****GOMA - METAL****JUEGO TASES DE GOMA PARA CARROCERÍAS DE ALUMINIO****32506**

## CARROCERÍA DE ALUMINIO



**PALANCA DE GOLPEAR  
REVISTIMIENTOS DE  
NYLON**

70823



**TAS DACTILADO  
CON REVISTIMIENTO  
DE GOMA - METAL**

70824



70822

**ÚTIL PARA DESENSAMBLAR  
PAÑOS DE PUERTA  
MATERIAL NYLON**



80828

**TAS PARA PERFILES  
NYLON**



80817

**TAS PARA ALINEADO  
DE PERFILES NYLON**



80819

**TAS PARA PERFILES  
RECTOS - CURVOS NYLON**

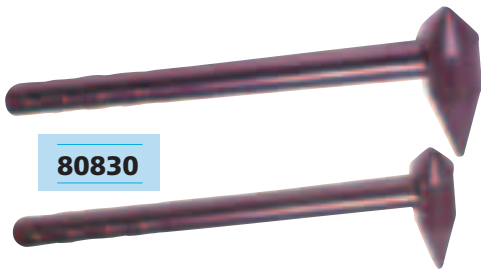

80830

80829

**MARTILLO PARA PLANCHA  
ALUMINIO NYLON**



80831

**TAS PARA PEQUEÑAS  
ABOLLADURAS  
NYLON**



80816

**NIVEL 3 POSICIONES  
PARA BANCADA**



80815

**NIVEL 3 POSICIONES  
PARA BANCADA**



**MORDAZA**

**10707**



**MORDAZA  
PRESIÓN**

**10911** 135 mm



**MORDAZA**

**10708**

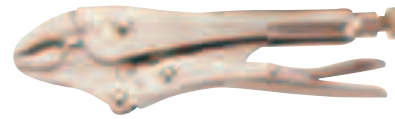

**MORDAZA  
PRESIÓN**

**10912** 190 mm



**10703** **MORDAZA**

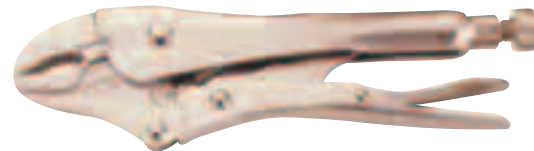

**MORDAZA PRESIÓN** **10913** 235 mm



**10705** **MORDAZA**



**MORDAZA  
CUELLO CISNE**

**10914**



**10704** **MORDAZA**



**10915** **MORDAZA CUELLO CISNE**



**MORDAZA**

**10706**



**10916** **MORDAZA SOLDADOR**  
2 garras



**14950** **MORDAZA DE PRESIÓN**  
Mordaza de horquilla de aluminio



**10917** **MORDAZA GARRAS  
PLANAS**



**10919** **MORDAZA CUELLO CISNE**  
18"



**10918** **MORDAZA CUELLO  
CISNE** 11"

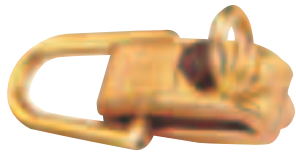

### MORDAZAS DE TIRO

**88301**

Capacidad: 3 tn  
 Capacidad en cruz: 2 tn  
 Superficie de agarre: 14x45 mm

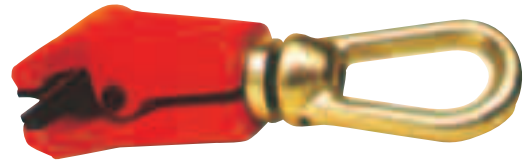

### MORDAZA DE TIRO

**88130** 100 mm



### MORDAZAS DE TIRO

**88302**

Capacidad: 2 tn  
 Superficie de agarre: 14x73 mm

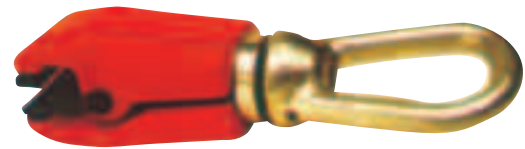

### MORDAZA DE TIRO

**88129** 60 mm

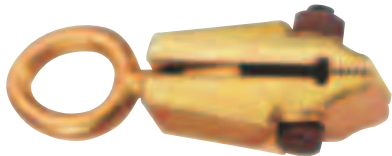

### MORDAZAS DE TIRO

**88303**

Capacidad: 5 tn  
 Superficie de agarre: 45x22 mm

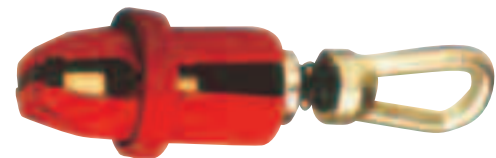

### MORDAZA DE TIRO

**88132** Skuba

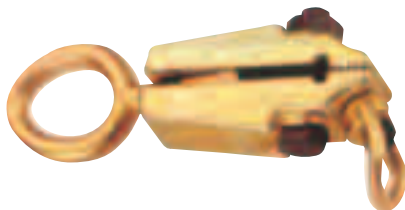

### MORDAZAS DE TIRO

**88304**

Capacidad: 5 tn  
 Capacidad en cruz: 2 tn  
 Superficie de agarre: 45x22 mm

### MORDAZAS DE TIRO MORDAZA MAGNUM Autoblocante

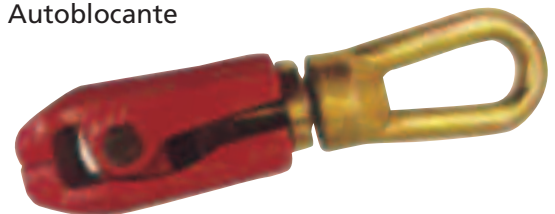

**88134** Capacidad: 5 tn  
 Autoapriete de mandíbulas de 60 mm de anchura de abrazadera

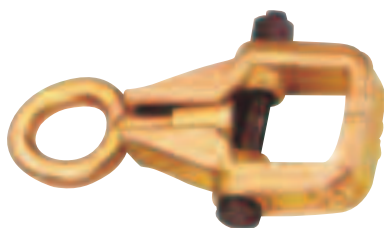

### MORDAZAS DE TIRO

**88305**

Capacidad: 3 tn  
 Superficie de agarre: 30x10 mm

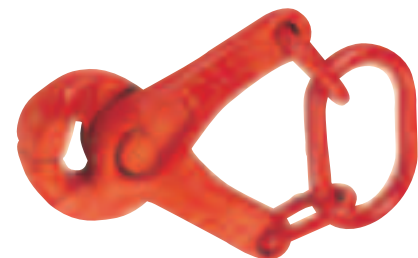

### MORDAZAS DE TIRO

**88144** Capacidad: 3 tn  
 Autobloqueante, sin tornillos de apriete



### MORDAZAS DE TIRO

**88306**

Capacidad: 3 tn  
 Capacidad en cruz: 2 tn  
 Superficie de agarre: 30x10 mm

**ARCOS DE TIRO GRANDE**

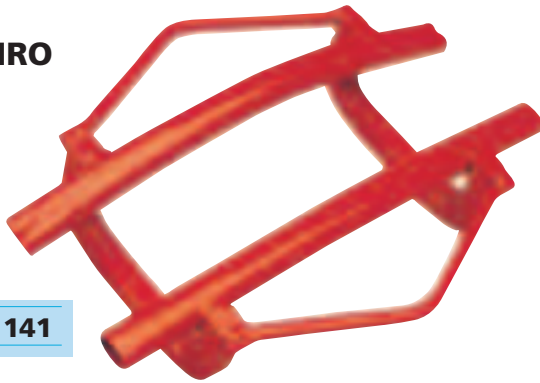

91141

**ARCOS DE TIRO PEQUEÑO**

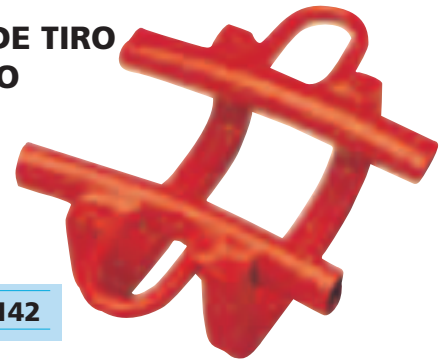

91142

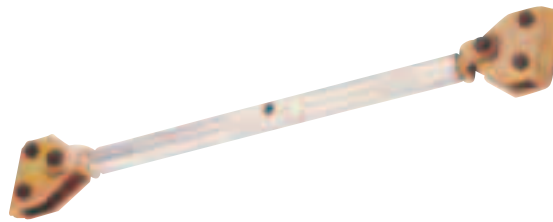

**TENSOR MONOBLOCK**

91143

780-1200 mm



**TENSOR MONOBLOCK**

91144

780-1850 mm



**KIT CINCHAS DE TIRO**

90901

1-80 cms x 6 cm.  
1-120 cms x 6 cm.  
1-160 cms x 6 cm.  
1-100 cms x 45 cm.



**GANCHO DE TIRO**

Art. 91910



**GANCHO DE TIRO**

Art. 82920



**BLOQUADOR DE CADENA**

Art. 93930



**CADENA 3 M CON GANCHO**

Art. 93002



## EXTRACTOR DE GRAPAS DE TAPIZADO

Corto

**88392**



## EXTRACTOR DE GRAPAS DE TAPIZADO

Fino

**88391**



## EXTRACTOR DE GRAPA TAPIZADO

**88390**



## EXTRACTOR DE GRAPA TAPIZADO

Largo

**31920**

Especial Seat - Audi - Skoda - VW



## EXTRACTOR DE GRAPA TAPIZADO

**81014**

Especial Seat, Audi, VW, Skoda



## LEVANTA GRAPAS CON WIHA MANGO DE FUERZA

Varilla de acero cromo-vanadio, templado continuo, cromado mate

Wiha mango de fuerza de acetil celulosa, resistente a golpes, rojo, exento de cadmio

**43010**



## EXTRACTOR DE GRAPAS DE TAPIZADO

Tapicería de tigrera

**12105**



## RECUPERADOR DE CERRADURAS

Para reparar agujeros dañados de cerraduras de puerta por golpe o intento de robo

**82369**



## JUEGO DE MANTAS PROTECTORAS IGNIFUGAS

Protegen las tapicerías, cristales, tableros y otros elementos del vehículo de las chispas de soldadura y elementos de corte, etc.. 2 mantas

**61033**

Manta 460 x 800 mm  
Manta 1500 x 2000 mm  
Soporte de temperatura  
600° C - Sin amianto



## KIT PARA ABRIR PUERTAS DE AUTOMÓVIL

y mantener cristales de ventanas en su posición mientras se realiza la reparación de los elevallas

**82409**

Diseño original

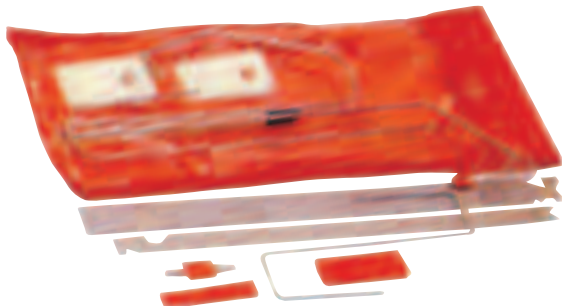

## JUEGO DE ESPADINES PARA ABRIR PUERTAS

Diseño original

**88106**



## KIT DE VISAGRAS DE PUERTAS

**31203**

VW, Seat, Avai, Skoda, Renault, Mercedes, Porsche, etc...

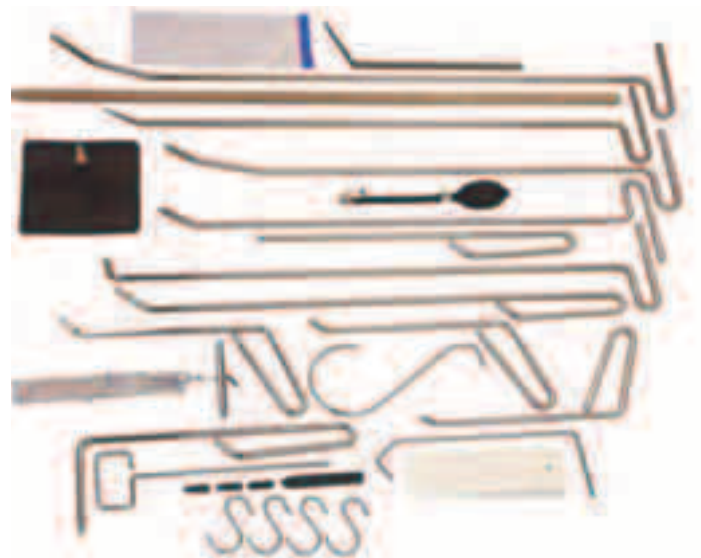

## KIT DE PALANCAS

Para pequeños golpes causados por el granizo, transporte, etc...

**82907**

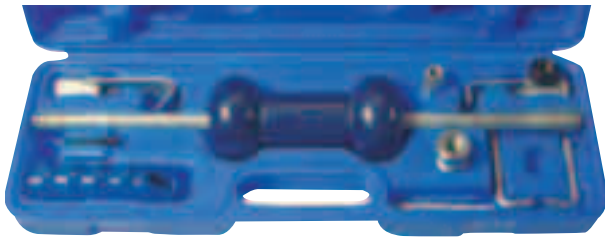

### TIRADOR DE INERCIA

Para plancha de carrocería

88910

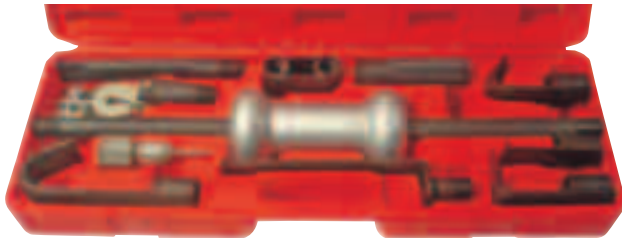

### TIRADOR DE INERCIA

Para plancha de carrocería, largo

88908

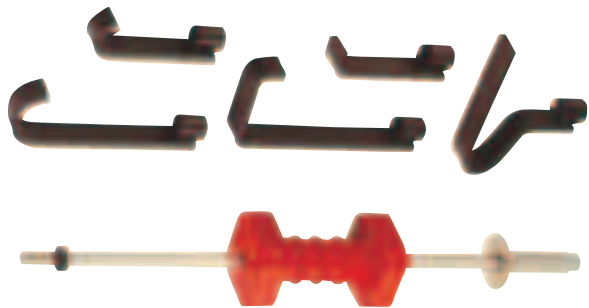

### TIRADOR DE INERCIA

Para plancha de carrocería,  
extra largo - extra fuerte

88100



### BLOQUEADOR DE CADENA

93930



### DOBLE CONECTADOR DE TIRO PARA CADENA

88923 6 Ton capacidad



### PLANCHA DE FIJACIÓN PARA TIRO CON CADENA

88113

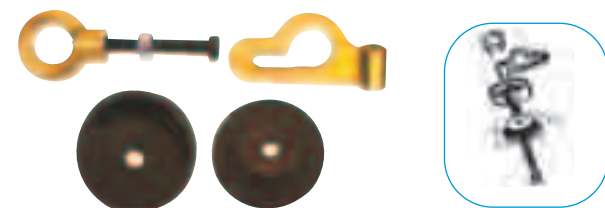

### ÚTIL PARA FIJACIÓN DE TIRO EN TORRETA

88104

### ÚTIL DE FIJACIÓN DE TIRO CON ESCUADRA

88105 4 Ton capacidad

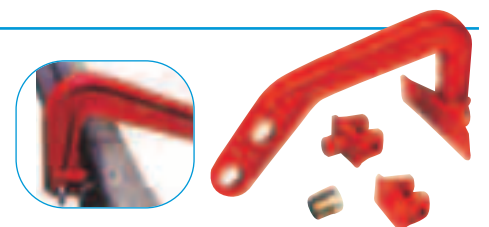

## REMACHADORA DOS BRAZOS PARA REMACHES Y TUERCAS REMACHABLES

Los sistemas de remachado Cheauto ofrecen cuatro alternativas en esta sección  
Sistema de alta calidad para trabajos pesados para tuercas y remaches

**10909**

- Remaches de aleación o acero inoxidable, 2,4 < 6,4 mm
- Remaches de tuerca: 4 < 10 mm
- Brazos extensible
- Mordazas de recambio



**10910**



## REMACHADORA CON CABEZA GIRATORIA

- Remaches: 2,4-4-4,8 mm
- Tuercas remachables: 4-5-6-8-10 mm
- Tornillo remachable: 4-5-6 mm

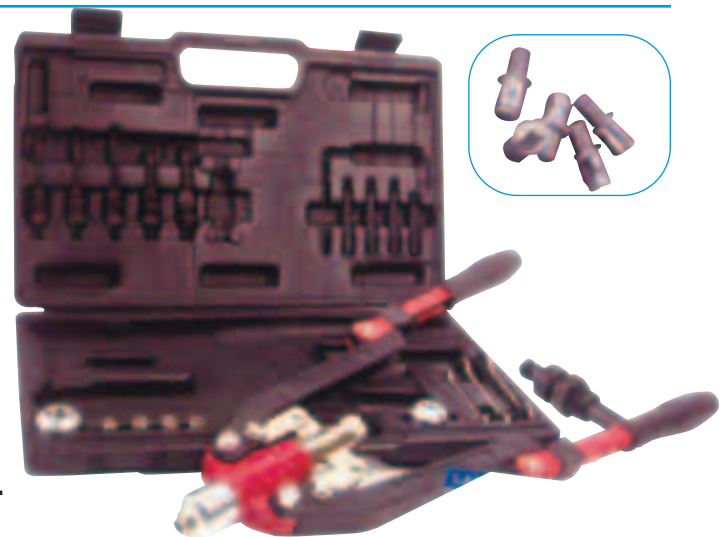
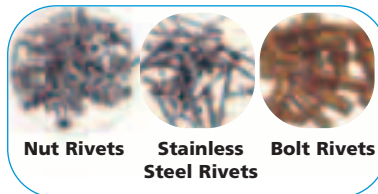

## REMACHADORA DE DOS BRAZOS PLEGABLE

**50911**

- Remaches: 3,2-4-4,8-6,4 mm
- Tuercas remachables: 4-5-6-8-10-12 mm
- Tornillo remachable: 4-5-6-8 mm



## REMACHADORA GIRATORIA PARA REMACHES EN LUGARES DE DIFÍCIL ACCESO

**50912** Remaches: 2,4-3,2-4-4,8 mm



**27328**

## REMACHADORA MANUAL

- Remaches: 2,4-3,2-4-4,8 mm

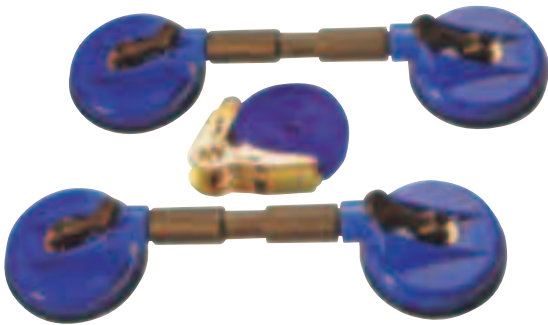

## JUEGO DE VENTOSAS PARA LUNAS

Con correa

61031



## VENTOSA SUPER

Para abolladuras de carrocería

99701

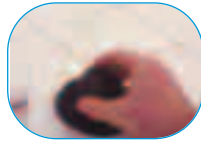

## MINI VENTOSA DE GOMA

Para pequeñas abolladuras de carrocería

99702



## VENTOSA SIMPLE DE CARROCERÍA

13980

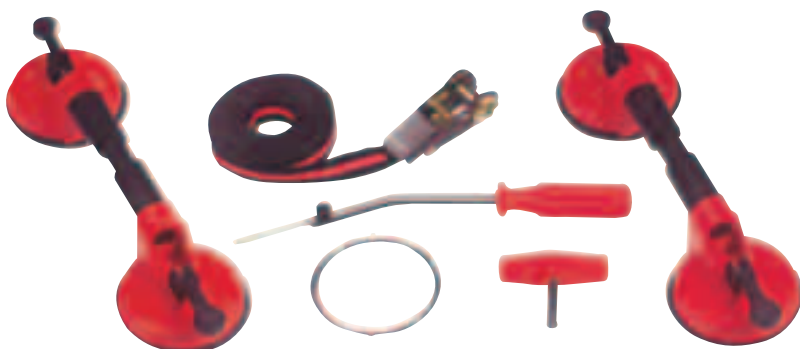

## SURTIDO PARA CRISTALES

6 piezas  
3,3 kgs

| 18002 | Pz | Descripción       |
|-------|----|-------------------|
|       | 1  | Palanca           |
|       | 1  | Tirante           |
|       | 1  | Filo de acero     |
|       | 2  | Ventosas          |
|       | 1  | Cinta con carraca |
|       | 1  | Pasador de cable  |

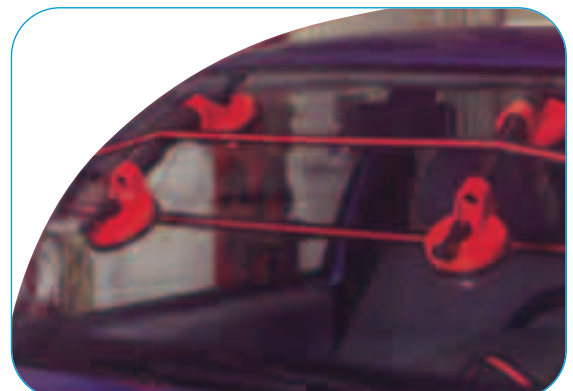



## TIRADOR DE CABLES CORTALUNAS

40200

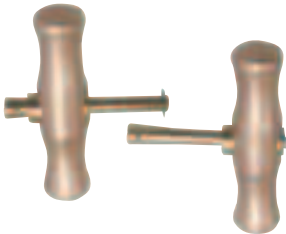

## TIRADOR DE CABLES CORTALUNAS

40018

## JUEGO TIRADORES CABLES CORTALUNAS

40210



## PASADOR DE CABLE PARA LUNAS

20021



## PASADOR DE CABLE PARA LUNAS

20025

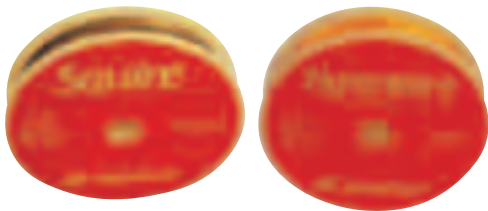

## ROLLO ALAMBRE

40011 Cuadrado

40012 Trenzado

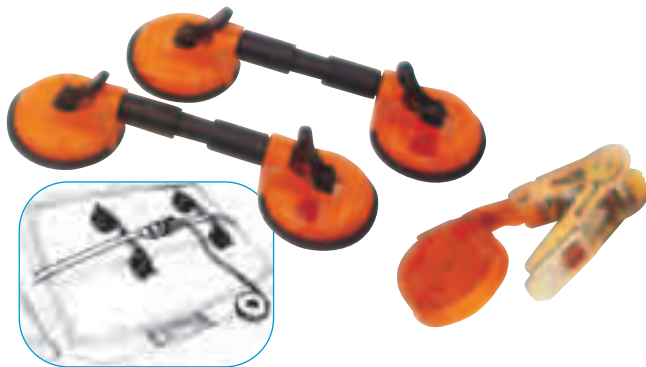

## VENTOSA PARA CRISTALES

Para el transporte y el posicionamiento de los cristales durante la operación de montaje y desmontaje. Ventosas orientables para adaptarse a superficies planas y curvas.

88000 Juego ventosas y correa para lunas

88001 Correa para ventosas de lunas

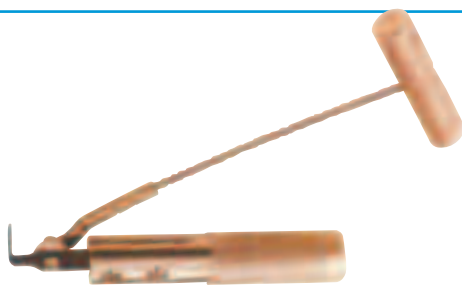

## ÚTIL CORTAJUNTAS DE PARABRISAS

35098



## CUCHILLA CORTALUNAS

38015 Recambio cortalunas 16 mm

38016 Recambio cortalunas 24 mm

38017 Recambio cortalunas 36 mm

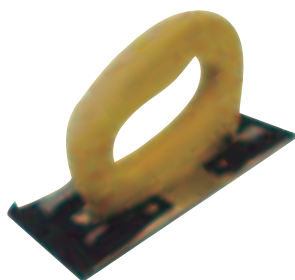

### LIMA PARA LIJAR

17 x 17 cms

17005

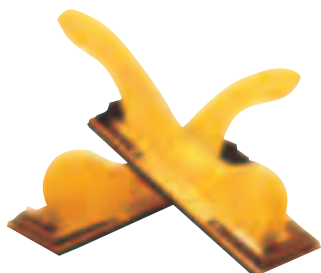

### LIMA PARA LIJAR

24 x 7 cms

17004

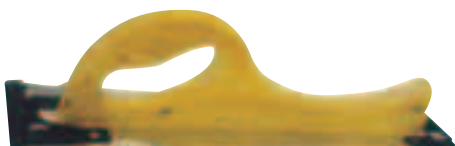

### LIMA PARA LIJAR

41 x 7 cms

17006

## JUEGO DE REPARACIÓN DE TERCIOPELO

### Contenido

- 40 colores de fibras de terciopelo
- 1 x saco de enfriamiento
- 1 x tijera
- 1 x rociador de bola
- 1 x brocha
- 1 x tejido de refuerzo
- 1 x 100 ml A-Stitch cola
- 1 x 50 ml A-Coat adhesiva

17108

- 1 x hoja de teflón
- 1 x 50 gr G-Compound
- 1 x set lápices de colores
- 1 x espátula
- 1 x cuchillo
- 1 x rociador de boca
- 1 x mini-plancha
- 1 x 300 ml Scotchguard



### FUNDA ASIENTO

21403 50 unidades



### FUNDA VOLANTE

21404 40 unidades

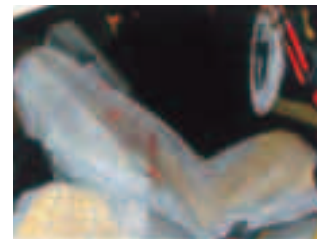

### JUEGO FUNDA VOLANTE MÁS ASIENTOS

21405 100 unidades

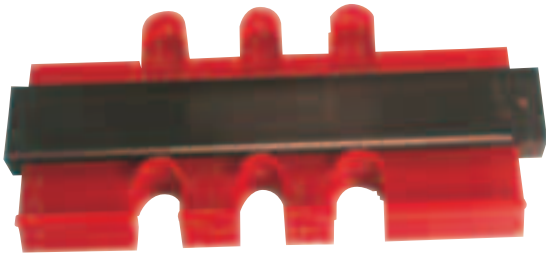

## COMPROBADOR DE PERFILES

**56101**



## TACO PARA LIJAR INP

**17001** Naranja, 21x10,5 cm



## TACO PARA LIJAR KAUPP

**17008** Naranja, 21x10,5 cm



## TACO PARA LIJAR KAUPP

**17009** Amarillo, 13x8 cm

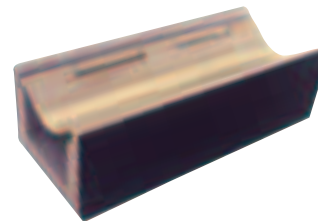

## TACO PARA PERFILES KAUPP

**17010** Negro, 11x5 cm



## JUEGO TACOS DE LIJAR

Este juego de tacos de lijar se compone de seis tacos de lijar, cinco de los cuales utilizan discos standard con velcro y se pueden adaptar a diferentes formas de la carrocería. El último taco de lijar se usa para cantos de difícil acceso y para formas complicadas

**17075**

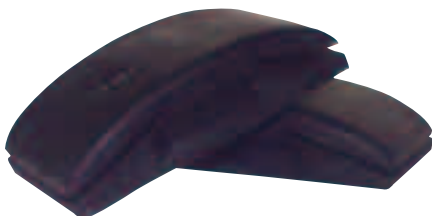

## TACO DE GOMA

**17012** Negro, 12x6,5 cm



## TACO PARA LIJAR PERFILES

**17011** Azul, flexible, para moldear en cualquier forma deseada



## LIJADOR DE CONTORNOS

**17042** Amarillo, flexible, para moldear en cualquier forma deseada



**CUCHILLO PARA EMPAQUE DE POLIURETANO**

44047



**CUCHILLA DE RECAMBIO**

44048

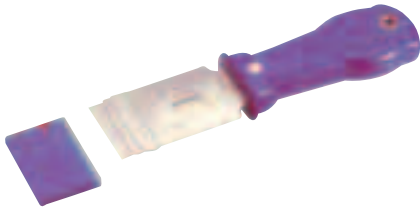

**ÚTIL RASCALUNAS**

65543



**RECAMBIO DE 10 CUCHILLAS**

65545



**EXTRACTOR DE OMEGAS DE ALZACRISTALES**

11776



**CORTATUBOS**

31500



**JUEGO DE CUCHILLAS DE RECAMBIO**

31530



**KIT PARA COLOCAR JUNQUILLOS DE LUNAS**

88002

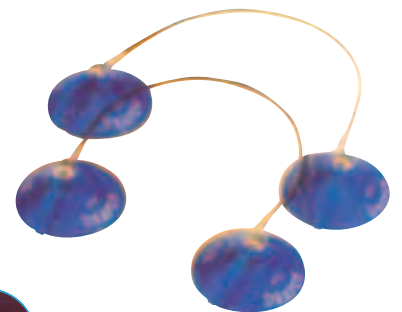

**JUEGO DE VENTOSAS PARA VENTANAS**

65541

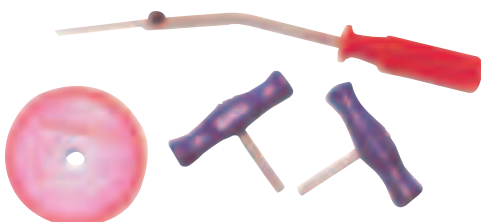

**CONJUNTO CORTALUNAS**

88003



## REMACHADORA PARA REMACHES DE PLÁSTICO

Especial para remaches de plástico que sostienen molduras, guardabarros interiores y otras partes plásticas

**83308**



## REMACHES PARA REMACHADORA DE PLÁSTICOS

En bolsas de 100 unidades

|              |          |
|--------------|----------|
| <b>69010</b> | S x 12   |
| <b>15502</b> | G x 12   |
| <b>79011</b> | G-S x 17 |
| <b>15524</b> | G-S x 18 |

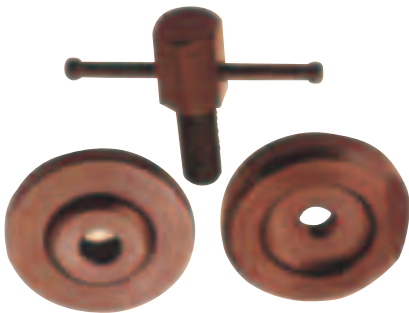

## KIR PARA REPARAR PLANCHAS DE ALOJAMIENTO DE CERRADURAS DE AUTOMÓVIL

**82369**



**81002**

## EXTRACTOR DE LIMPIAPARABRISAS

Herramienta simple pero eficaz que permite sacar fácil y rápidamente brazos de limpiaparabrisas agarrotados

Adecuado para pernos alargados y pernos alargados con lengüeta

Su diseño compacto ofrece un acceso fácil en lugares confinados y elimina

el riesgo de dañar el brazo del limpiaparabrisas y la pintura de alrededor

Esta herramienta puede utilizarse en la mayoría de los vehículos

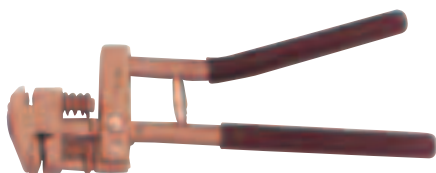

## ALICATES DE PUNZONAR Y PLEGAR

Modelo de cabezas móviles par apunzonar y plegar los bordes de las chapas soldadas

**86411**

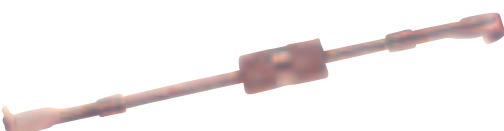

## TIRADOR DE PLANCHA A GOLPES

**88595**

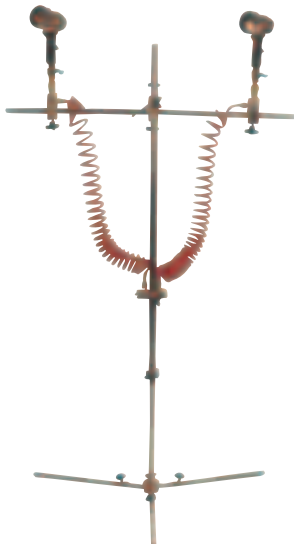

## KIT PARA SECADO DE PINTURA

Descripción:

Acorta el tiempo de secado para todos los materiales de base agua (pinturas, barnices, etc)

Ideal para el secado de pinturas en pequeñas reparaciones (puertas, aletas, guardabarros, etc)

Evitar el calentar toda la cabina

**81004** Trípode + 2 pistolas Venture



## PISTOLA DE SECADO VENTURE

**81001**



## SOPORTE GIRATORIO CON GANCHOS TELESCÓPICOS

Para fijación de piezas de carrocería, para recubrirlos de impregnación o pintura

**83090**



## PROTECTOR DE CANTOS PARA LIJADO MANUAL O CON MÁQUINA

**80308**

## DETECTOR DE RUIDOS DE CARROCERÍA Y MOTOR

**80433**

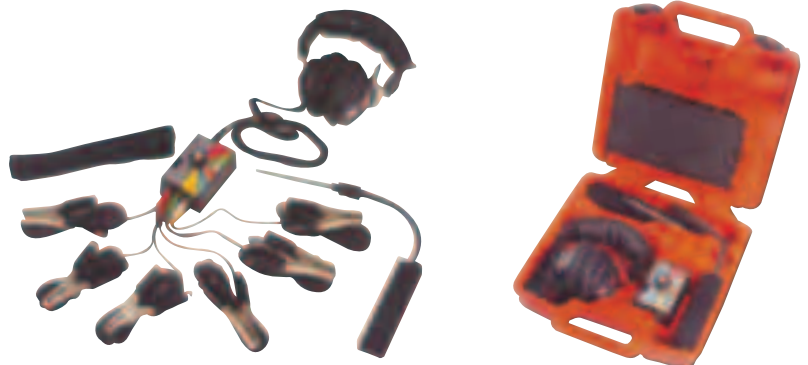



### MICROMETRO

Para medir el grosor de la capa de pintura

**80102**

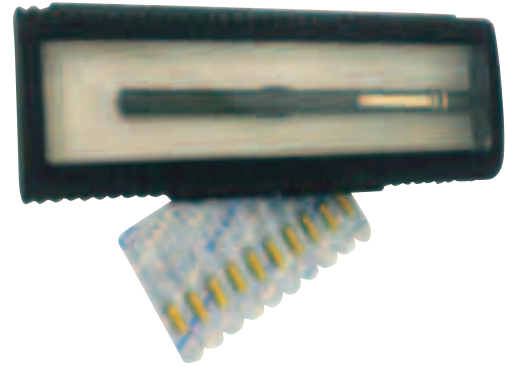

### JUEGO DE AGUJAS ANTIPOLVO CON SOPORTE

Para levantar fácilmente los granos de polvo de la pintura fresca  
ideal para eliminar las pequeñas partículas que puedan caer sobre la pintura aplicada, sin dejar señal en la misma

**11003** 10 agujas + soporte



### JUEGO RASCADORES DE MOTAS DE PINTURA

**11002**

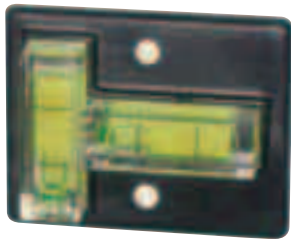

### NIVEL DE BANCADA

**11001**



### JUEGO DE BROCHAS

22 unidades para limpiar pistolas, en caja de plástico

**11004** 6 agujas + soporte, brochas diferentes + soporte, aceite para pistolas, etc

**83503** CARETA SOLDADOR

**83504** CRISTAL DE RECAMBIO





## ESTRELLA PARA SPOOTER

En bolsas de 50 unidades

82296



## CLAVO PARA SPOOTER

82294 2x50 mm Bolsas de



82293 2,5x50 mm Bolsas de



## ARANDELA COBRE PARA SPOOTER

802296 En bolsa de 100 unidades



## JUEGO 5 CARBONCILLOS

82305



## ÚTIL DE TIRO PARA ESPIRALES

82306

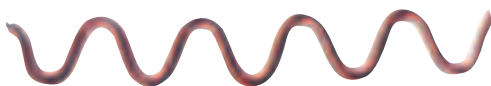

## BOLSA DE 50 ESPIRALES

82307



## MARTILLO DE TIRO PARA 82306

22201



## CEPILLO DE ALAMBRE PUAS DE ACERO

20594



## PINZA DE MASA PARA SPOOTER

82510

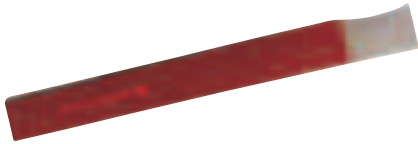

## ESCARPA PARA DESENSAMBLAR

Plancha recta

92007

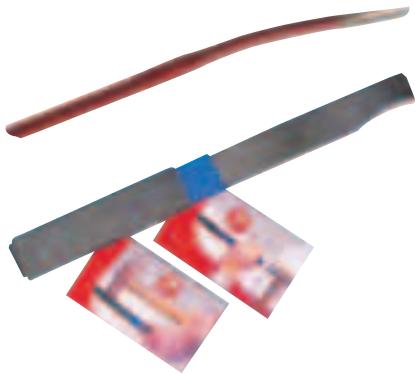

## ESCARPA PARA DESENSAMBLAR

Plancha curva 30°  
Corte a 2 caras y punta

92008

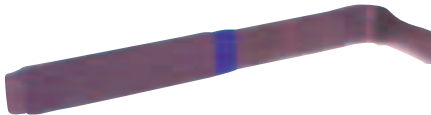

## ESCARPA PARA DESENSAMBLAR

Plancha 90°  
Corte a 2 caras y frontal

92011



## JUEGO ESCARPAS PARA DESENSAMBLAR CHAPA

92021

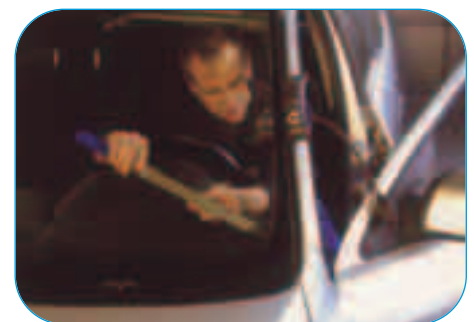
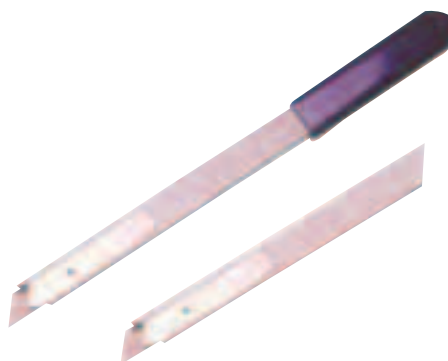
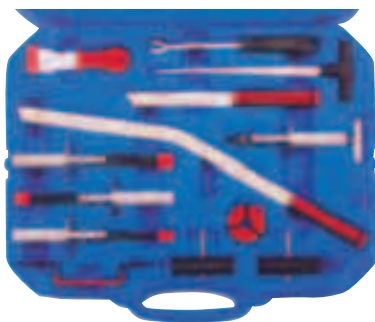

## 31803 KIT CORTALUNAS MANUAL DE 14 PIEZAS

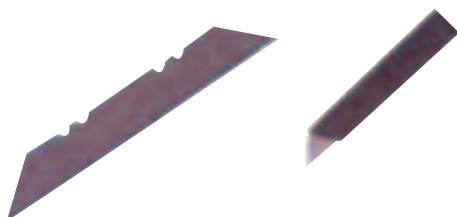

## CUCHILLA DE RECAMBIO PARA CORTALUNAS MANUAL

31804

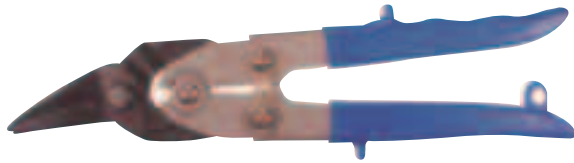

### TIJERA PLANCHA

Corte a derecha

39310

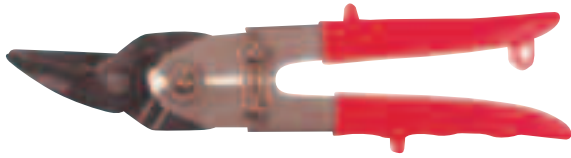

### TIJERA PLANCHA

Corte a izquierda

39311

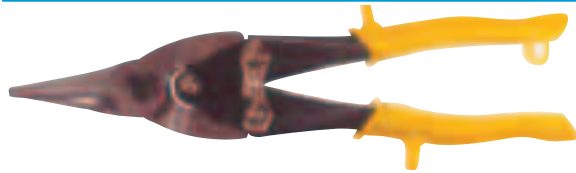

### TIJERA PLANCHA

Corte recto

39312



### TIJERA PLANCHA REFORZADA

Corte a izquierdas

39313



### TIJERA PLANCHA REFORZADA

Corte a derechas

39314



### JUEGO DE 5 PIEZAS EN INOX PARA DESENSAMBLAR TAPIZADOS

91552

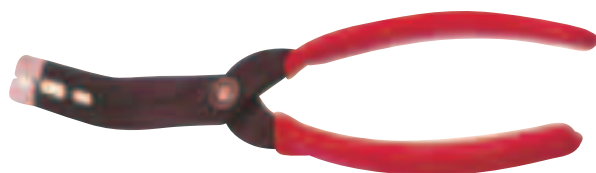

### ALICATE PARA GRAPAS DE TAPIZADO

33004

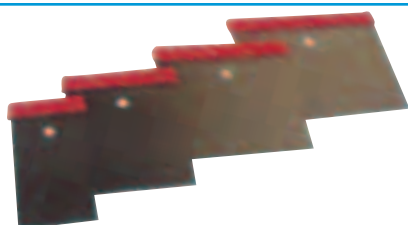

### JUEGO DE 4 ESPÁTULAS

50 - 80 - 100 - 120 mm

44100



**MASA PARA SPOOTER**

**37501**



**PORTA UTILES PARA SPOOTER**

**37502**

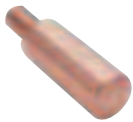

**37585**

**PINZA PARA DAR TEMPERATURA A LA PLANCHA**



**32081**

**PUNZON SOLDADOR**

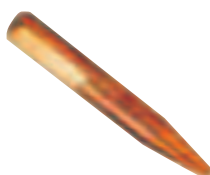

**32082**

**PUNZON SOLDADOR**

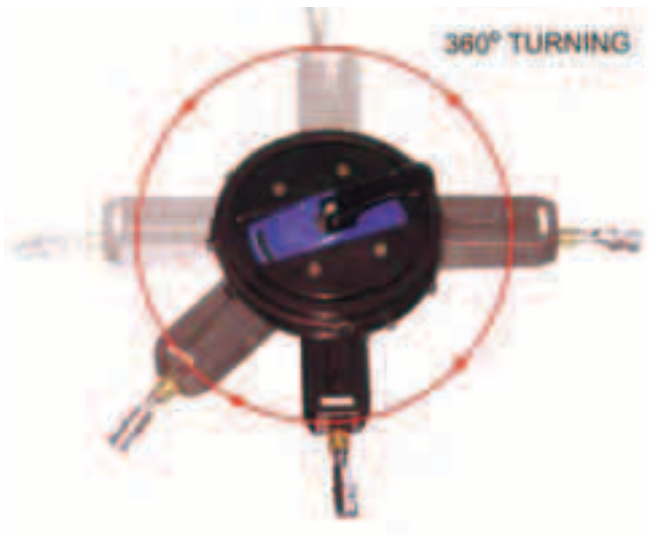

## KIT DE EXTRAER LUNAS CON VENTOSA GIRATORIA

76099

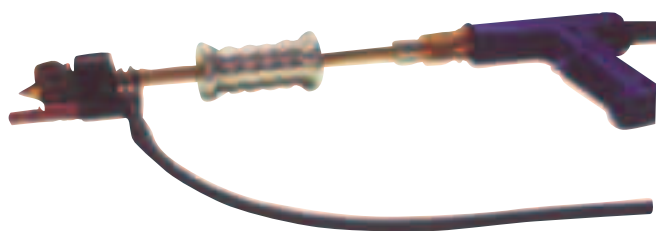
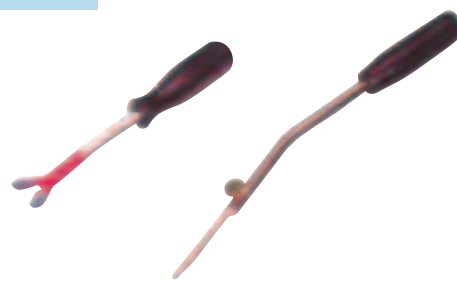

## MASA PARA PISTOLAS SPOTER MULTIFUNCIÓN

En el momento de apuntar se produce el contacto con la chapa y hace la masa

64392

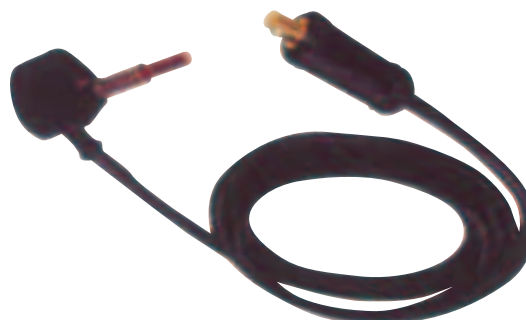
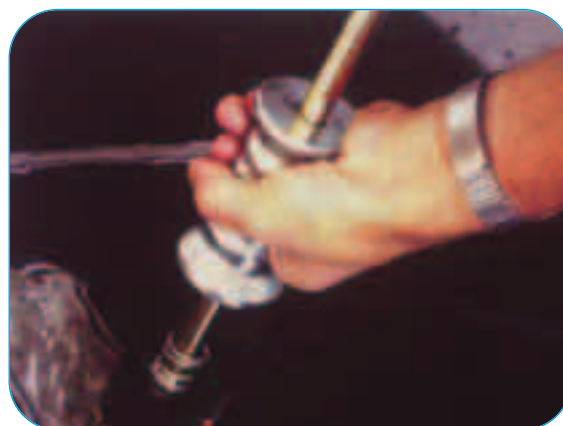



## KIT DE 5 MORDAZAS ESPECIALES PARA CARROCERÍA

61201



## JUEGO 16 MORDAZAS PARA CHAPISTA



33355

- 5 mordazas boca curva grande 220x65 mm
- 3 mordazas horquilla 235x65 mm
- 5 mordazas boca curva pequeña 185x55 mm
- 3 mordazas cuello cisce 280x140 mm

Todos los modelos están equipados con mangos recubiertos de goma confortable para un manejo cómodo y seguro. Este completo juego asegura que el trabajador tenga disponible la mordaza correcta para el trabajo requerido

## JUEGO CÍNCLES DE PVC

**JUEGO DE CUCHILLAS PLÁSTICAS**, de plástico reforzado con fibra de vidrio, 4 medidas

4 cuchillas plásticas en los anchos: 19 - 22 - 26 - 38 mm por ej. para extracción de molduras y listones de ventanas con cuidado del barniz, hoja de cuchilla flexible y puntera percutora para golpes livianos, utilizable también como extractor adhesivos sobre llantas de aluminio



91181



91182

**CÍNCEL DE PVC**



85256

## KIT DE ALMOHADILLAS HINCHABLES

- Para abrir puertas
- Para despegar lunas
- Para mantener lunas laterales levantadas durante reparación de elevelunas, etc



**81151**

### MARTILLO ALUMINIO

Round pane Aluminium hammer gr 50  
Single packed in carton box

**81150**

### MARTILLO ALUMINIO

Round pane Aluminium hammer gr 120  
Single packed in carton box

**81153**

### MARTILLO ALUMINIO

Square pane Aluminium hammer gr 120  
Single packed in carton box

**81154**

### MARTILLO ALUMINIO

Aluminium mallet gr 450  
Single packed in carton box

**81155**

### MARTILLO ALUMINIO

Round pane Aluminium hammer gr 80  
Single packed in carton box

**81156**

### MARTILLO ALUMINIO

Turned square pane Aluminium gr 120  
Single packed in carton box

**81157**

### MARTILLO ALUMINIO

Bent square pane Aluminium gr 120

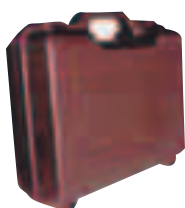

**80170**

### SET DE MARTILLO ALUMINIO

Set of 7  
Aluminium  
hammers



**21014**

### KIT PARA VISAGRAS DE PUERTA DE AUTOMÓVIL

M10 x T45 x 300 MM  
Applicable: VW, Audi, Seat, Skoda, Mercedes, Renault,  
Bits Size: M8, M10, M12, T30, T40, T45, T50



### TACO DE LIJAR

Para disco 150 mm - Velcro

20197



### TACO DE LIJAR

125x70 mm

20197



### TACO DE LIJAR

Para disco 150 mm - Velcro

22322



### TACO DE LIJAR

Para disco de 150 mm. Borde lateral flexible

21021



### TACO DE LIJAR

Para disco 125 mm - Velcro

20920



### TACO DE LIJAR

Para disco de 150 mm. Velcro

22022